

Powerex, Inc., 173 Pavilion Lane, Youngwood, Pennsylvania 15697 (724) 925-7272
www.pwr.com

POW-R-BLOK™
Dual Diode Isolated Module
1000 Amperes / Up to 4000 Volts

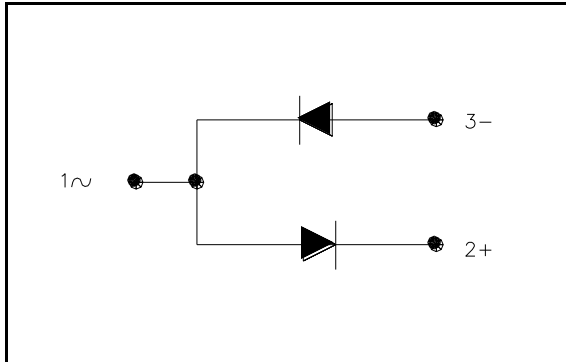

Ordering Information:

Select the complete eight-digit module part number from the table below.
Example: PD414010 is a 4000 Volt, 1000A Average Dual Diode Isolated POW-R-BLOK™ Module

Type	Voltage Volts (x100)	Current Amperes (x100)
PD41	36	10
	38	
	40	

Description:

Powerex Dual Diode Modules are designed for use in applications requiring rectification and isolated packaging. The modules are isolated for easy mounting with other components on a common heatsink.

Features:

- Electrically Isolated Heatsinking
- Compression Bonded Elements
- Metal Baseplate
- Low Thermal Impedance for Improved Current Capability
- UL Recognized (E78240)

Benefits:

- No Additional Insulation Components Required
- Easy Installation
- No Clamping Components Required
- Reduce Engineering Time

Applications:

- Bridge Circuits
- AC & DC Motor Drives
- Battery Supplies
- Power Supplies
- Large IGBT Circuit Front Ends

Absolute Maximum Ratings

Characteristics	Conditions	Symbol	Units	
Repetitive Peak Reverse Blocking Voltage		V_{RRM}	Up to 4000	V
Non-Repetitive Peak Blocking Voltage ($t < 5$ msec)		V_{RSM}	$V_{RRM} + 100V$	V
RMS Current Per Diode (180° Conduction)	180° Conduction, $T_C=79^\circ C$	$I_{F(RMS)}$	1725	A
	180° Conduction, $T_C=87^\circ C$	$I_{F(RMS)}$	1570	A
	180° Conduction, $T_C=95^\circ C$	$I_{F(RMS)}$	1415	A
	180° Conduction, $T_C=103^\circ C$	$I_{F(RMS)}$	1255	A
Average Forward Current Per Diode (180° Conduction)	180° Conduction, $T_C=79^\circ C$	$I_{F(AV)}$	1100	A
	180° Conduction, $T_C=87^\circ C$	$I_{F(AV)}$	1000	A
	180° Conduction, $T_C=95^\circ C$	$I_{F(AV)}$	900	A
	180° Conduction, $T_C=103^\circ C$	$I_{F(AV)}$	800	A
Peak One Cycle Surge Current, Non-Repetitive $T_j = 25^\circ C, V_r = 0$	60 Hz	I_{FSM}	48,300	A
	50 Hz	I_{FSM}	41,060	A
Peak One Cycle Surge Current, Non-Repetitive $T_j = 25^\circ C, V_r = V_{rrm}$	60 Hz	I_{FSM}	32,200	A
	50 Hz	I_{FSM}	27,375	A
Peak One Cycle Surge Current, Non-Repetitive $T_j = 125^\circ C, V_r = 0$	60 Hz	I_{FSM}	42,000	A
	50 Hz	I_{FSM}	35,700	A
Peak One Cycle Surge Current, Non-Repetitive $T_j = 125^\circ C, V_r = V_{rrm}$	60 Hz	I_{FSM}	28,000	A
	50 Hz	I_{FSM}	23,800	A
Peak Three Cycle Surge Current, Non-Repetitive	60 Hz, $T_j = 125C, V_r = V_{rrm}$	I_{FSM}	22,480	A
Peak Ten Cycle Surge Current, Non-Repetitive	60 Hz, $T_j = 125C, V_r = V_{rrm}$	I_{FSM}	17,660	A
I^2t for Fusing for One Cycle $T_j = 125^\circ C, V_r = V_{rrm}$	8.3 milliseconds	I^2t	3.26×10^6	$A^2 \text{ sec}$
	10 milliseconds	I^2t	2.83×10^6	$A^2 \text{ sec}$
I^2t for Fusing for One Cycle $T_j = 25^\circ C, V_r = 0$	8.3 milliseconds	I^2t	9.72×10^6	$A^2 \text{ sec}$
	10 milliseconds	I^2t	8.43×10^6	$A^2 \text{ sec}$
Operating Temperature		T_J	-40 to +150	$^\circ C$
Storage Temperature		T_{stg}	-40 to +150	$^\circ C$
Max. Mounting Torque, M6 Mounting Screw			132	in. – Lb.
			15	Nm
Max. Mounting Torque, M10 Terminal Screw			106	in. – Lb.
			12	Nm
Module Weight, Typical			5.33	kg
			11.75	lb
V Isolation @ 25°C	60Hz V_{rms} 60 sec	V_{rms}	4000	V

Information presented is based upon manufacturers testing and projected capabilities.
 This information is subject to change without notice.
 The manufacturer makes no claim as to suitability for use, reliability, capability,
 or future availability of this product.

Electrical Characteristics, T_J=25°C unless otherwise specified

Characteristics	Symbol	Test Conditions	Min.	Max.	Units
Repetitive Peak Reverse Leakage Current	I _{RRM}	Up to 4000V, T _J =150°C		200	mA
Peak On-State Voltage	V _{FM}	I _{FM} =3000A, T _J =25°C		1.35	V
Threshold Voltage, Low-level	V _{(TO)1}	T _J = 150°C, I = 15%I _{T(AV)} to πI _{T(AV)}		0.741	V
Slope Resistance, Low-level	r _{T1}			0.132	mΩ
Threshold Voltage, High-level	V _{(TO)2}	T _J = 150°C, I = πI _{T(AV)} to I _{TSM}		0.840	V
Slope Resistance, High-level	r _{T2}			0.119	mΩ
V _{FM} Coefficients, Full Range		T _J = 150°C, I = 50A to 6kA V _{FM} = A+ B Ln I +C I + D Sqrt I	A = B = C = D =	0.7903 -1.11 E-02 1.27 E-04 1.01 E-03	
Typical Reverse Recovery Time	t _{rr}	T _J = 25°C, I _{fm} = 1500A. di _r /dt = 25 A/us, t _p = 190 us		25	μs

Thermal Characteristics

Characteristics	Symbol		Max.	Units
Thermal Resistance, Junction to Case	R _{ΘJ-C}	Per Module, both conducting Per Junction, both conducting	0.029 0.058	°C/W °C/W
Thermal Impedance Coefficients	Z _{ΘJ-C}	Z _{ΘJ-C} = K ₁ (1-exp(-t/t ₁)) + K ₂ (1-exp(-t/t ₂)) + K ₃ (1-exp(-t/t ₃)) + K ₄ (1-exp(-t/t ₄))	K ₁ = 5.04 E-04 K ₂ = 2.31 E-03 K ₃ = 2.83 E-03 K ₄ =5.24 E-02	t ₁ = 2.47 E-03 t ₂ = 4.42 E-02 t ₃ = 1.370 t ₄ = 9.668
Thermal Resistance, Case to Sink Lubricated	R _{ΘC-S}	Per Module	0.009	°C/W

Typical On-State Forward Voltage Drop
(T_J = 150C)

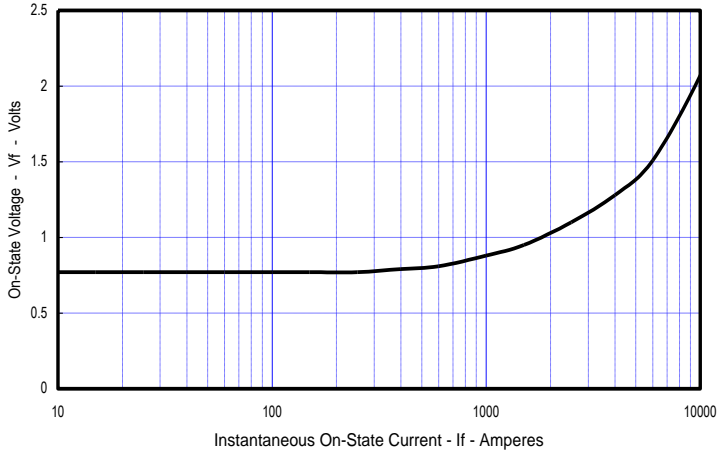

Maximum Transient Thermal Impedance
(Junction To Case)

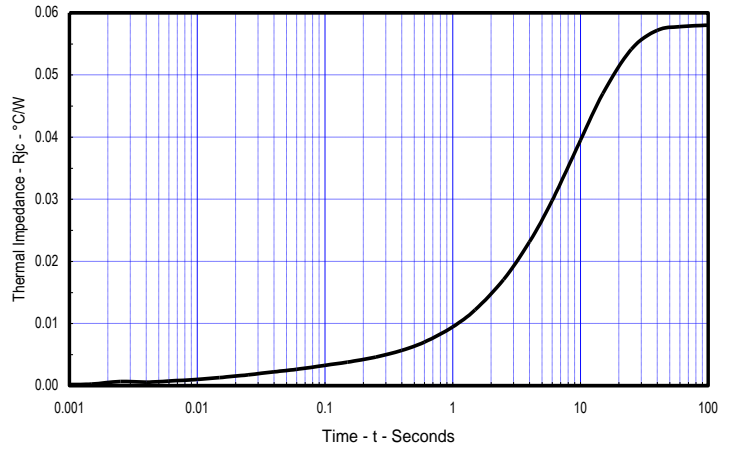

Maximum On-State Power Dissipation
(Sinusoidal Waveform)

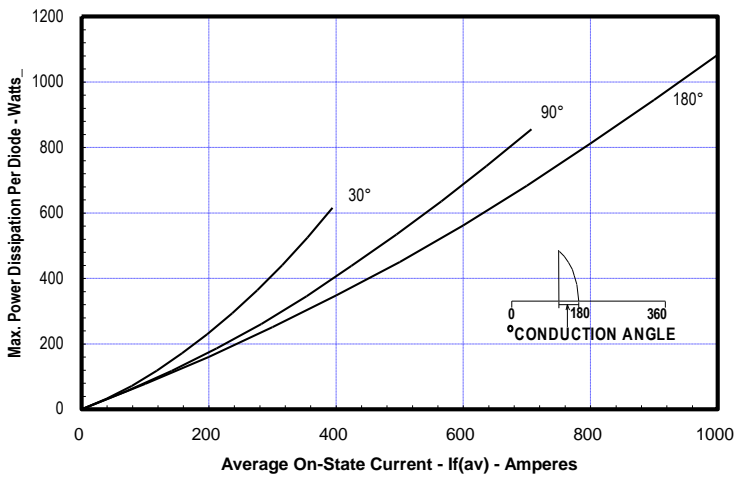

Maximum Allowable Case Temperature
(Sinusoidal Waveform)

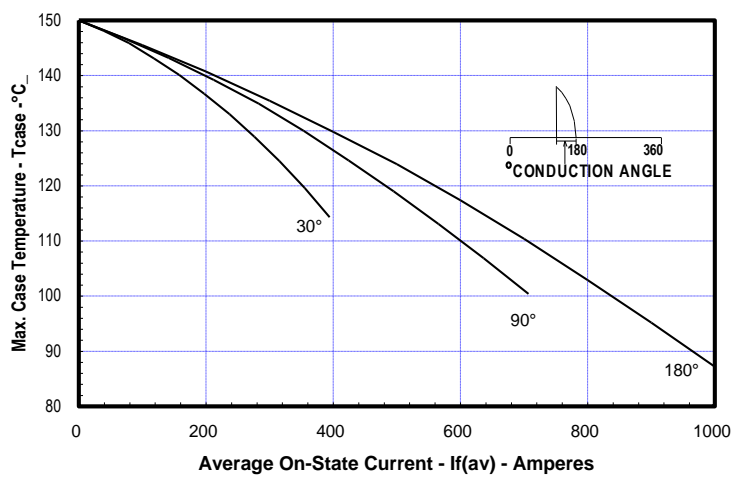

Maximum On-State Power Dissipation
(Rectangular Waveform)

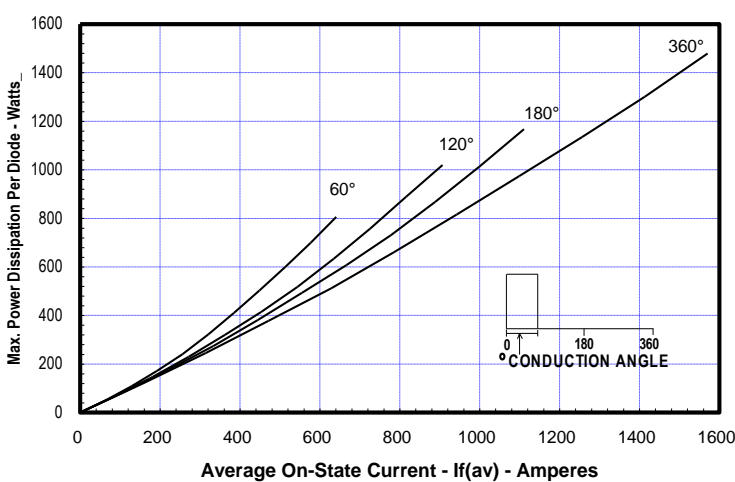

Maximum Allowable Case Temperature
(Rectangular Waveform)

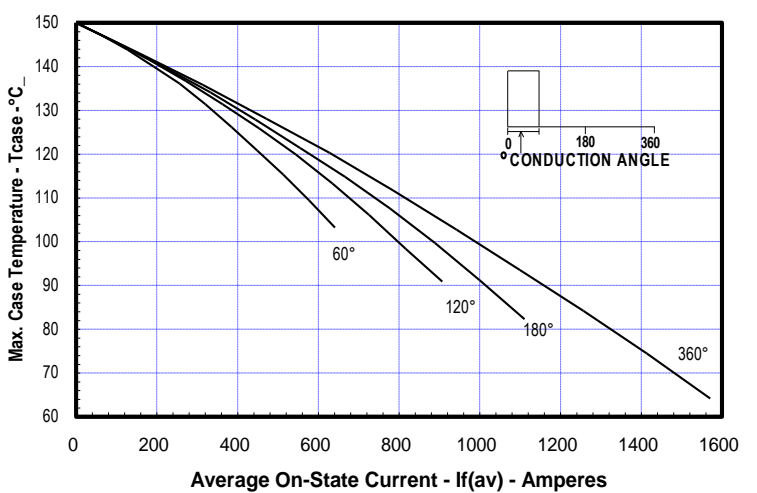

Powerex, Inc., 173 Pavilion Lane, Youngwood, Pennsylvania 15697 (724) 925-7272
 www.pwrx.com

POW-R-BLOK™ Dual Diode Isolated Module 1000 Amperes / Up to 4000 Volts

DIM.	INCHES	MILLIMETERS
A	7.80	198.1
B	4.00	101.6
C	2.68	68.1
D	6.44	163.6
E	3.44	87.4
F	.28	7.1
G	7.31	185.7
H	7.00	177.8
M	.281	7.1
N	.45	11.4
P	.54	13.7
Q	5.93	150.6
R	.19	4.8
T	.48	12.2
U	2.28	58
W	4.93	125.2
X	3.81	96.8
Z	2.00	50.8
AA	1.00	25.4
BB	.50	12.7
CC	1.00	25.4
DD	.406	10.3
EE	2.87	72.9
FF	.66	16.8

